

Toroidal Transformers type TAPCB

Audio-grade, single-phase mains toroidal transformers, manufactured with Class II insulation and IP00 protection degree, according to EN 61558.

Ultra-efficient, low-loss transformers for through-hole mounting in low-voltage PSUs designed for audio equipment. Toroidal technology ensures maximum efficiency, low leakage field and compact size. The polyurethane-flooded design ensures noiseless and vibration-free operation.

Transformers can be made according to the customer's specifications and equipped with the following components:

- interwinding static shielding (pin 3-12)
- magnetic shielding
- thermal protection
- customized primary and secondary voltages

Technical details:

Nominal power:	80 - 160 VA
Primary voltages:	230 V (pin 1-2); 2x115 V (pin 1-2, 13-14) (custom-on request)
Nominal frequency:	50 – 60 Hz
Secondary voltages:	according to the table of typical designs or other – on request
Construction / Insulation class:	II / B (130°C)
Ambient temperature:	40°C
Protection degree:	IP00

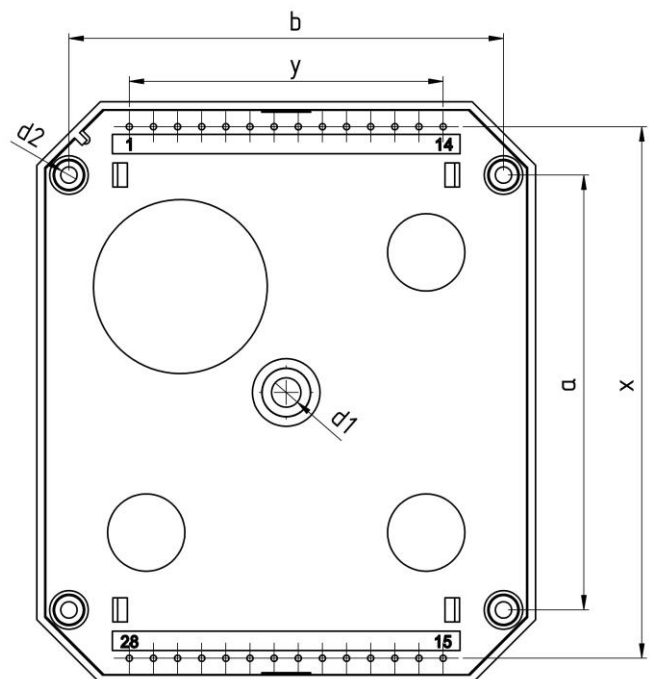
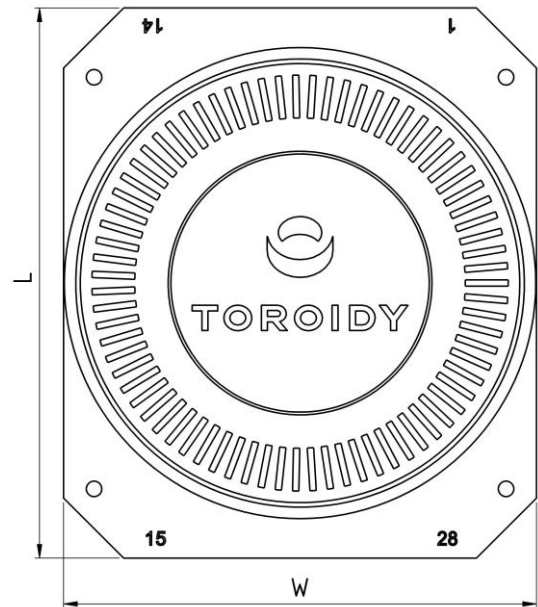
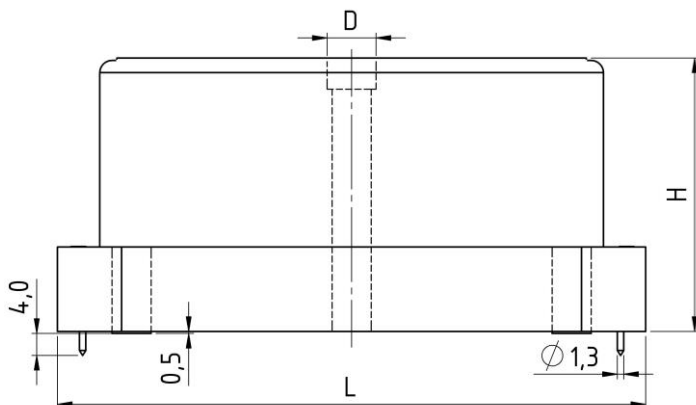

Mechanical characteristics of standard types:

Nominal Power	L	W	H	d1	d2	D (SW-Hex)	a	b	x	y
	±0,5mm	±0,5mm	±0,5mm	±0,2mm	±0,2mm	±0,2mm	±0,2mm	±0,2mm	±0,2mm	±0,2mm
30VA	90,2	73,2	44	5,1	3,4	7	60	60	80	7x5
40VA	100	83,2	44	5,1	3,4	7	70	70	90	9x5
50VA	110,2	93,3	51,1	6,1	3,4	10	80	80	100	11x5
60 VA	110,2	93,3	51,1	6,1	3,4	10	80	80	100	11x5
80VA	120,3	103,3	56,1	6,1	3,4	10	90	90	110	13x5
100 VA	120,3	103,3	56,1	6,1	3,4	10	90	90	110	13x5
120 VA	120,3	103,3	56,1	6,1	3,4	10	90	90	110	13x5
160 VA	120,3	103,3	56,1	6,1	3,4	10	90	90	110	13x5

Max. center screw length = H – 1mm

Electrical characteristics and PCB layout for standard types:

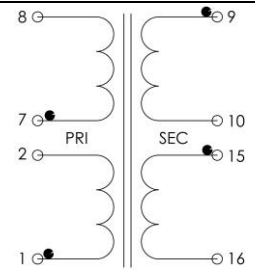
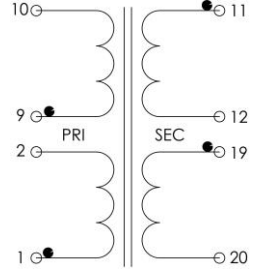
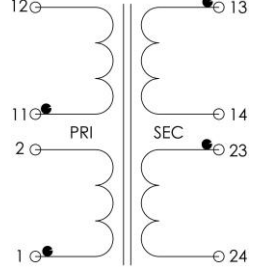
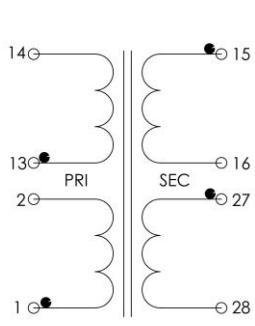
Nominal Power	Primary Voltage PRI	Type:	Secondary Voltage SEC	Total pin no. (available pins)	Pin layout for 2x 115V PRI and double SEC
30VA	230V (pin 1-8) or 2 x 115V (pin 1-2, 7-8)	TAPCB-30VA Box – Wz 7173 Pin plates – Wz 7177	2 x 3,15V; 2 x 6V – 2 x 60V	16 (3-6), (11-14)	
40VA	230V (pin 1-10) or 2 x 115V (pin 1-2, 9-10)	TAPCB-40VA Box – Wz 7040 Pin plates – Wz 7036	2 x 3,15V; 2 x 6V – 2 x 60V	20 (3-8), (13-18)	
50VA	230V (pin 1-12) or 2 x 115V (pin 1-2, 11-12)	TAPCB-50VA Box – Wz 7193 Pin plates – Wz 7197	2 x 3,15V; 2 x 6V – 2 x 60V	24 (3-10), (15-22)	
60 VA		TAPCB-60VA Box – Wz 7193 Pin plates – Wz 7197			
80VA	230V (pin 1-14) or 2 x 115V (pin 1-2, 13-14)	TAPCB-80VA Box – Wz 7200 Pin plates – Wz 7207	2 x 3,15V; 2 x 6V – 2 x 60V	28 (3-12), (17-26)	
100 VA		TAPCB-100VA Box – Wz 7200 Pin plates – Wz 7207			
120 VA		TAPCB-120VA Box – Wz 7200 Pin plates – Wz 7207			
160 VA		TAPCB-160VA Box – Wz 7200 Pin plates – Wz 7207			

Nominal parameters can be adjusted to meet customer needs.
Voltages, currents and the number of secondary and primary windings can be changed.